

Stage 1

10 rounds

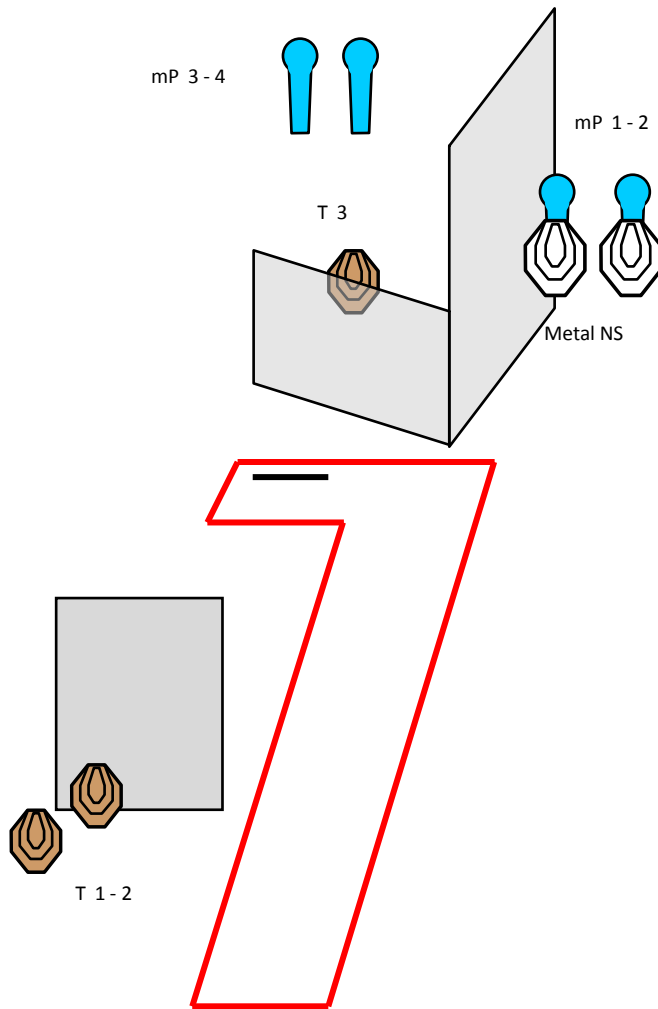

Type of Course	Short course
Targets	3 IPSC Target, 4 IPSC Mini Poppers, No Shoots
Rounds to be scored	10
Possible points	50
Start position	Standing, the toes touching the black line.
Gun state	Loaded, chamber empty.
Time starts	Audible signal
Procedure	On signal, engage all targets .

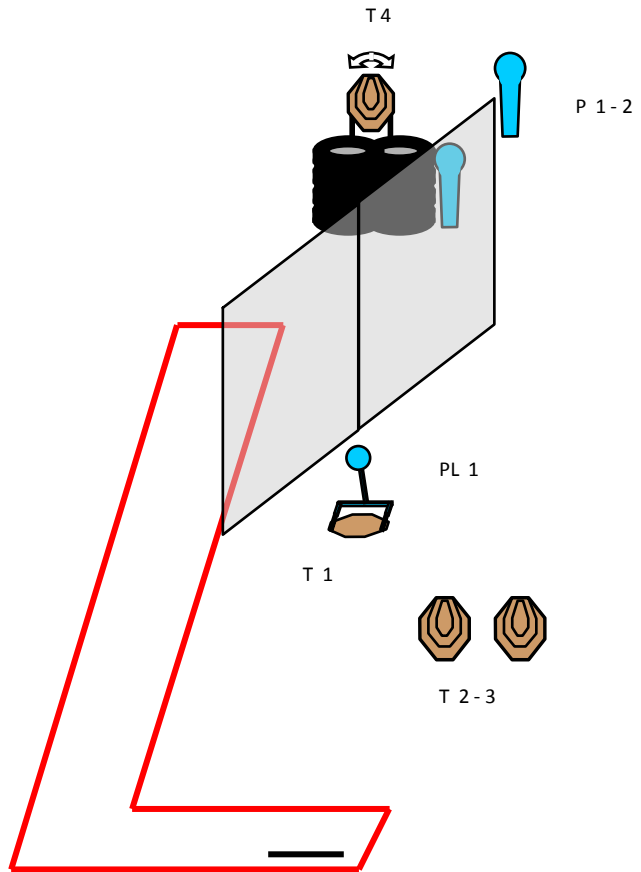

Type of Course	Short course
Targets	4 IPSC Targets, 2 IPSC Popper, 1 Plate
Rounds to be scored	11
Possible points	55
Start position	Standing , heels touching the black line.
Gun state	Loaded, chamber empty.
Time starts	Audible signal
Procedure	On signal, engage all targets. P 1 activate T4. All moving targets remain visible at rest.

Stage 3

32 rounds

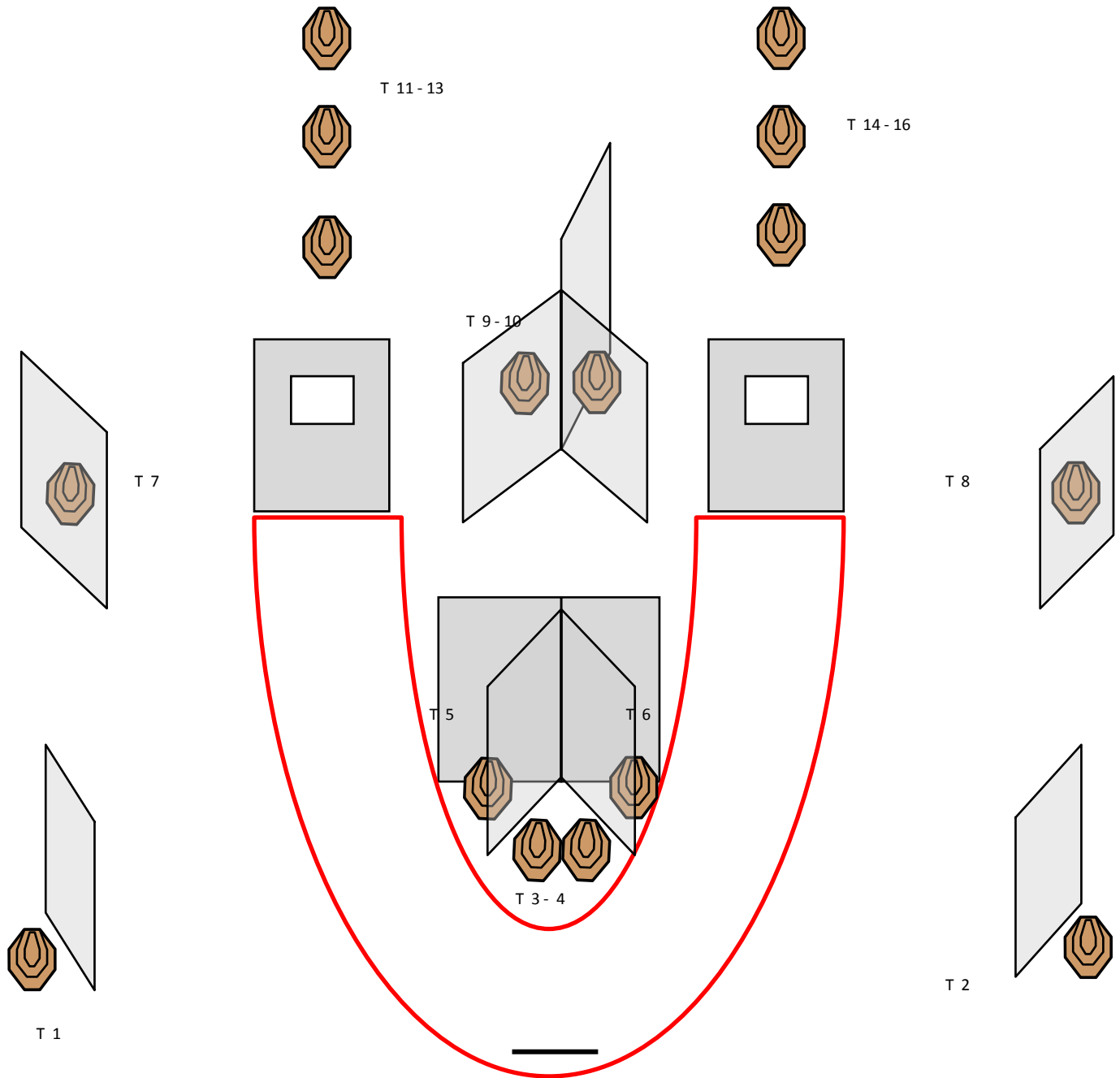

Type of Course	Long course
Targets	16 IPSC Targets
Rounds to be scored	32
Possible points	160
Start position	Standing , heels touching the black line.
Gun state	Gun loaded and holstered.
Time starts	Audible signal
Procedure	At the start signal engage targets from within the designated area.

Stage 4

24 rounds

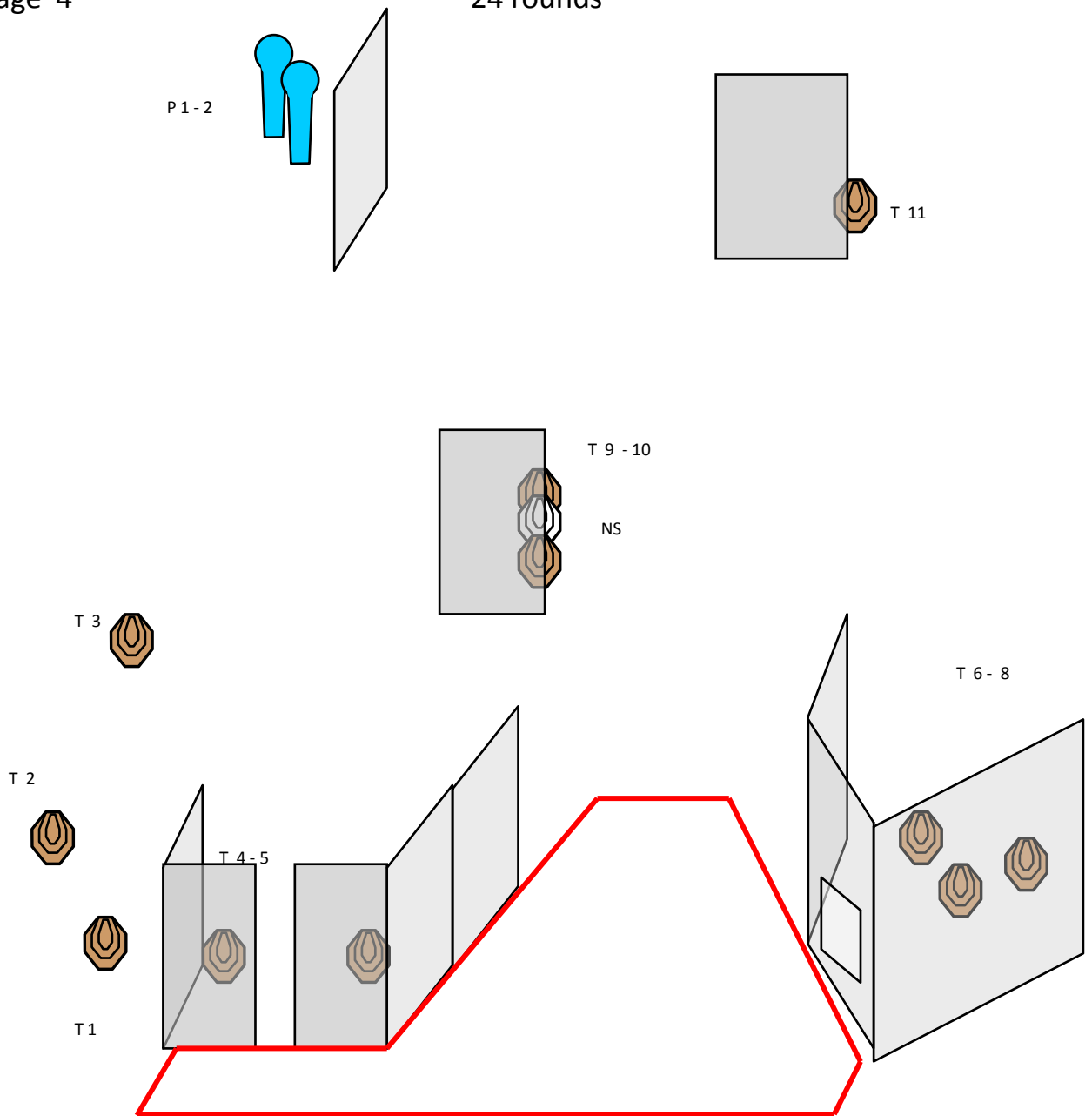

Type of Course	Medium course
Targets	11 IPSC Targets, 2 IPSC Poppers, No Shoots
Rounds to be scored	24
Possible points	120
Start position	Standing anywhere in marked area
Gun state	Gun loaded and holstered.
Time starts	Audible signal
Procedure	At the start signal engage targets from within the designated area.

Stage 5

12 rounds

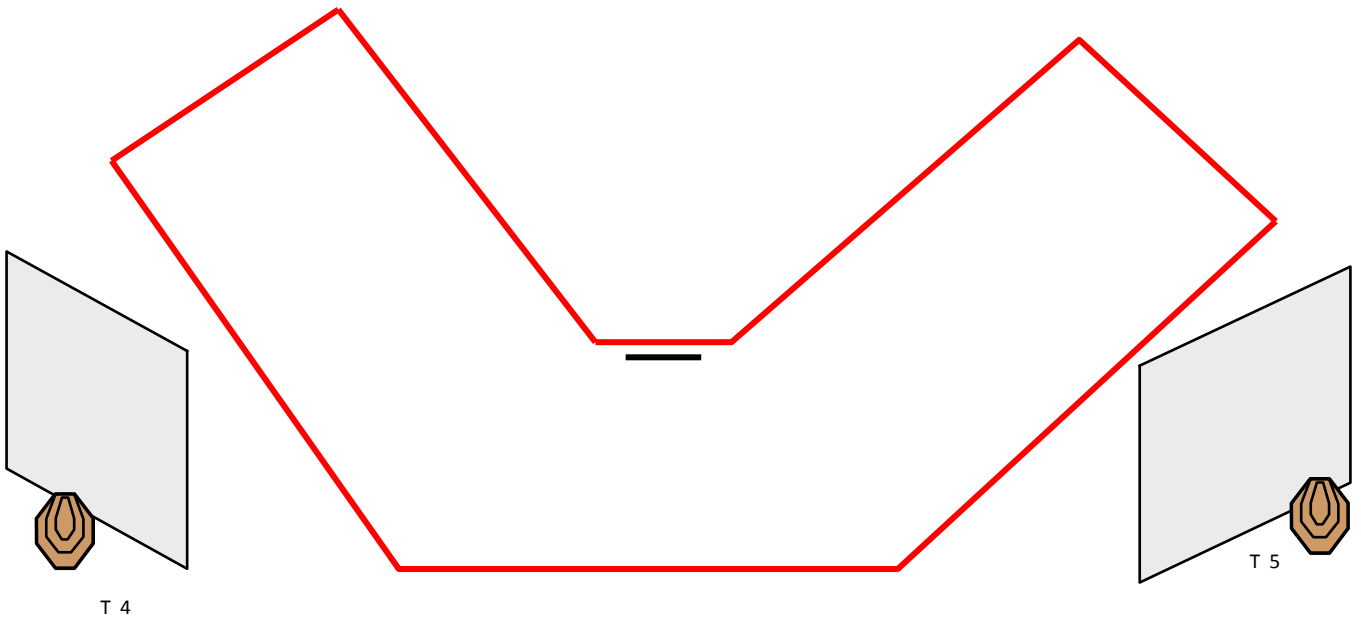
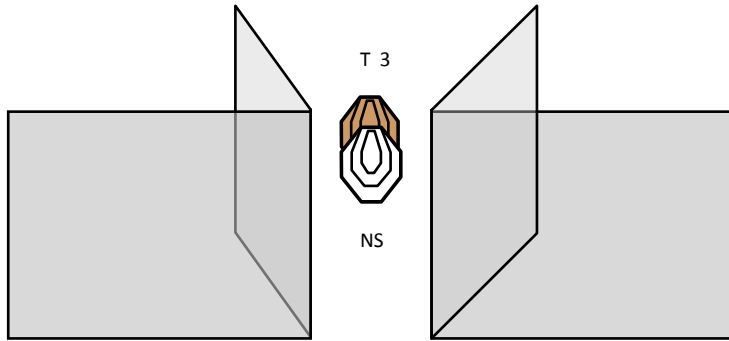
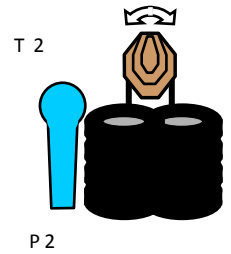
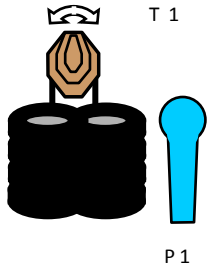

Type of Course	Short course
Targets	5 IPSC Targets, 2 IPSC Poppers
Rounds to be scored	12
Possible points	60
Start position	Standing , heels touching the black line.
Gun state	Unloaded
Time starts	Audible signal
Procedure	At the start signal engage targets from within the designated area. P 1 and P 2 activates T 1 and T 2. All moving targets remain visible at rest.

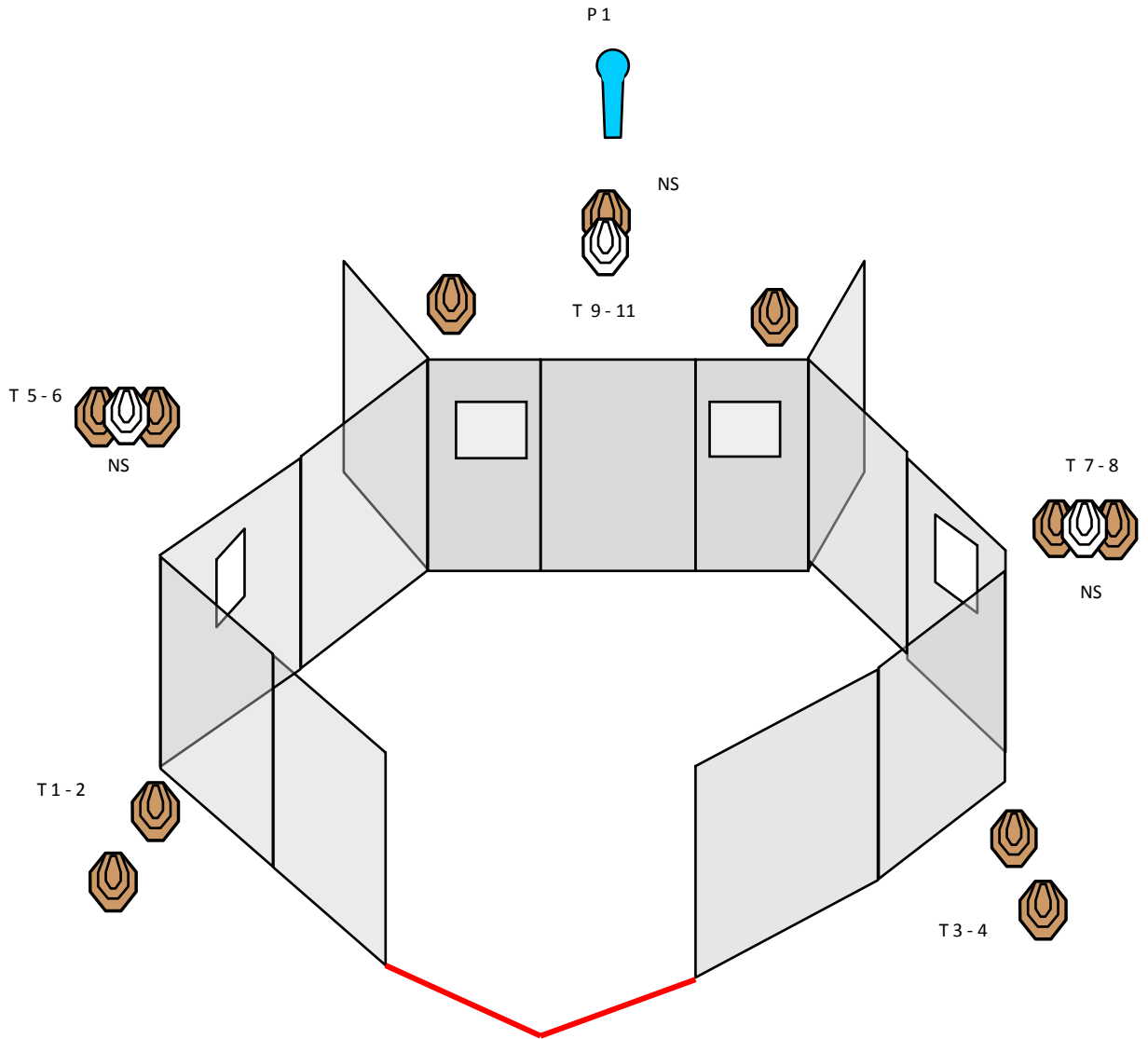

Type of Course	Medium course
Targets	11 IPSC Targets, 1 IPSC Popper, No Shoots
Rounds to be scored	23
Possible points	115
Start position	Standing anywhere in marked area.
Gun state	Gun loaded and holstered.
Time starts	Audible signal
Procedure	At the start signal engage targets from within the designated area.